

STOOLS
TŘÍSKOVÉ OBRÁBĚNÍ

TRVÁNÍ AKCE OD 1. DUBNA DO 24. KVĚTNA 2024

**Xill-tec® – Univerzální eXcellence pro
frézovací aplikace!**

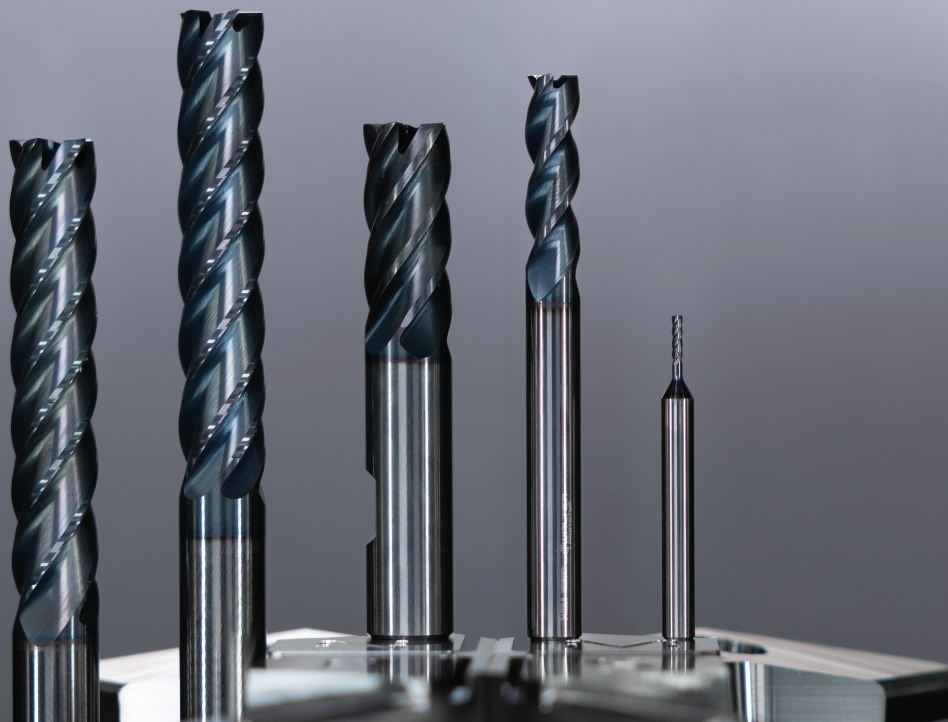

UŠETŘÍTE
50%

WALTER
PROTOTYP

- Univerzální použití ve všech materiálech ISO
- Rozsáhlý sortiment: s rohovými rádiusy, ochrannou fazetkou, hladkou stopkou a stopkou Weldon
- Dlouhá životnost díky vysoce výkonné sortě WK40TF
- Nabrousitelná ve všech renovačních centrech Walter se zárukou výkonu



FRÉZY ZE SLINUTÉHO KARBIDU MC230 A MC233 ADVANCE

Xill-tec® – eXcelentní univerzální frézování.

NÁSTROJ

- Frézy Xill-tec® MC230 a MC233 Advance s děličem třísky
- Rozsah průměrů: 2–25 mm
- z2–z8
- Délka břitu (Lc): 1 × Dc až 5 × Dc
- Nová geometrie s proměnnou spirálou; nerovnoměrná rozteč uzpůsobená podle počtu zubů (z)

SORTA

- Univerzální, houževnatá sorta pro frézování WK40TF: s povlakem TiAlN

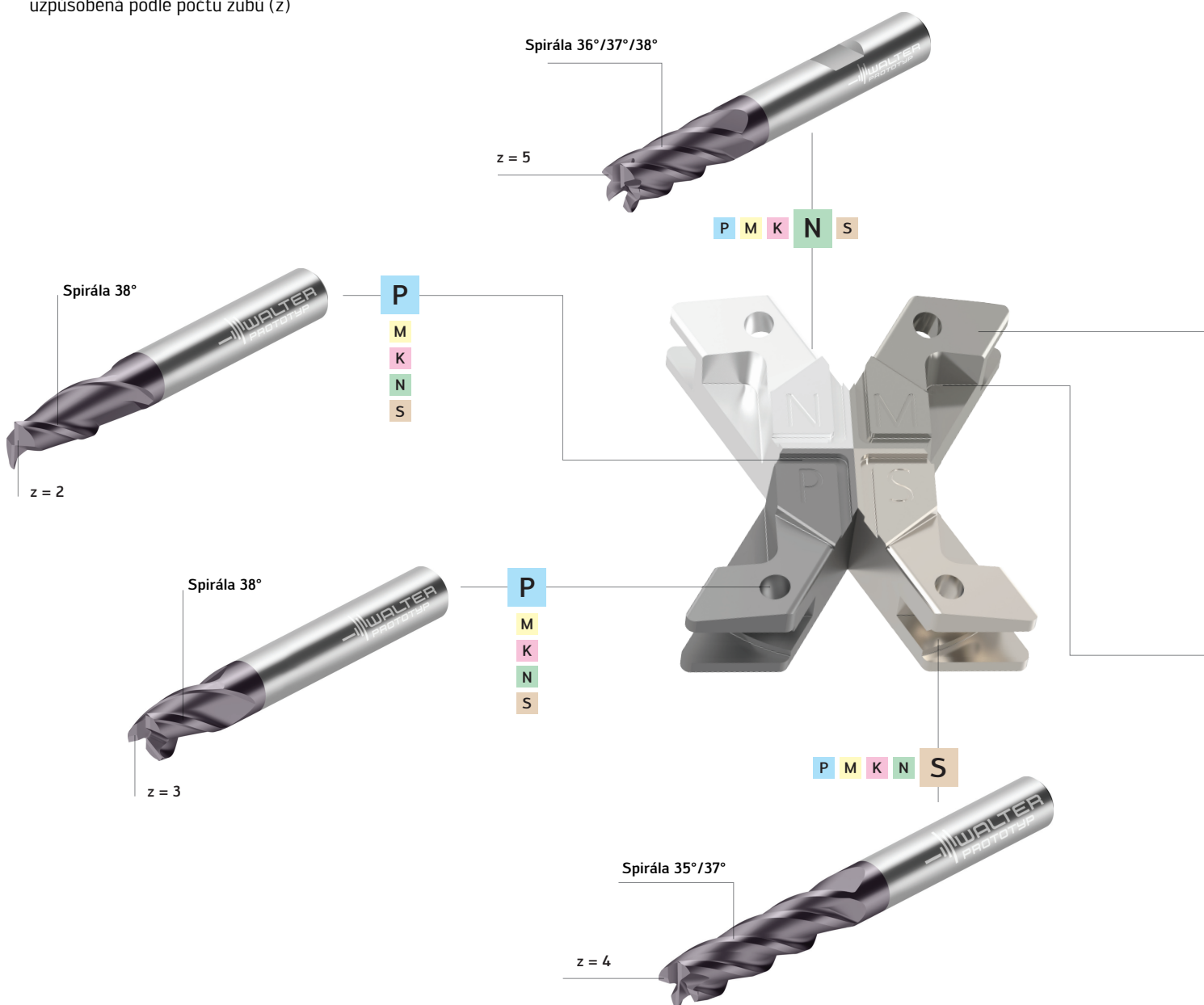

Fréza ze slinutého karbidu Xill-tec® MC230 Advance

Fig.: Xill-tec® MC230 Advance WK40TF

POUŽITÍ

1. volba o univerzální hrubování a dokončování

- Pro materiály ISO P, M, K, N a S
- z2–z3: frézování plných drážek, těsných per a profilů
- z4: frézování plných drážek a spirálové frézování, plunging, šikmé zanoření
- z5: hrubovací/dokončovací nástroj
- z6–z8: dynamické frézování a dokončování
- Oblasti použití: všeobecné strojírenství, výroba nástrojů a forem, subdodavatelé pro letecký a kosmický průmysl, lékařská technika, energetický a automobilový průmysl



Fréza ze slinutého karbidu
Xill-tec® MC233 Advance

Fig.: Xill-tec® MC233 Advance
WK40TF

PŘÍKLAD POUŽITÍ

Modulový závěs

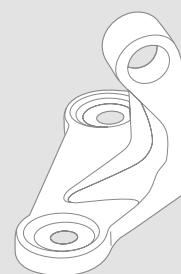

Materiál: GJS400-18 /
Č. materiálu: 5.3105 [160 HB]

Nástroj: MC233-25.0W8XL-WK40TF

Řezné parametry	Konkurence	Xill-tec® MC233 Advance
D _c (mm)	25	25
z	8	8
v _c (m/min)	154	154
f _z (mm)	0,28	0,28
v _f (mm/min)	4390	4390
a _e (mm)	0,33	0,5
a _p (mm)	125	125
Q (cm ³ /min)	183	257
T _e (min)	6	4

Porovnání: životnost nástroje v ks

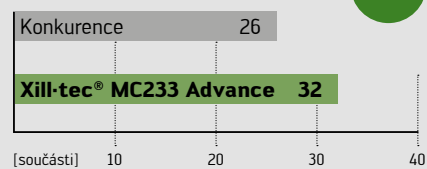

PŘÍNOS PRO VÁS

- Univerzální použití ve všech materiálech ISO se všemi běžnými frézovacími strategiemi
- Optimálně klidný chod a prodloužení životnosti díky speciální geometrii

Rohová/drážkovací fréza ze slinutého kربidu MC230 Advance

Xill-tec®

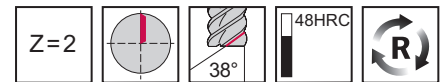
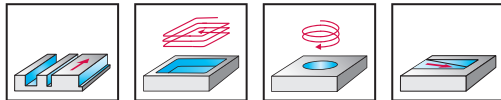

	P	M	K	N	S	H	O
WK40TF	●	●	●	●	●		

Označení	D _c	R	L _c	z	SAP č.	K _s
MC230-02.0A2B-BOW-TF	2		6.0	2	8361591	
MC230-02.5A2B-BOW-TF	2.5		7.0	2	8361592	
MC230-03.0A2B-BOW-TF	3		7.0	2	8361593	
MC230-03.5A2B-BOW-TF	3.5		7.0	2	8361594	
MC230-04.0A2B-BOW-TF	4		8.0	2	8361595	
MC230-04.5A2B-BOW-TF	4.5		8.0	2	8361596	
MC230-05.0A2B-BOW-TF	5		10.0	2	8361597	
MC230-06.0A2B-BOW-TF	6		10.0	2	8361598	
MC230-07.0A2B-BOW-TF	7		13.0	2	8361599	
MC230-08.0A2B-BOW-TF	8		16.0	2	8361610	
MC230-09.0A2B-BOW-TF	9		16.0	2	8361611	
MC230-10.0A2B-BOW-TF	10		19.0	2	8361612	
MC230-11.0A2B-BOW-TF	11		22.0	2	8361613	
MC230-12.0A2B-BOW-TF	12		22.0	2	8361614	
MC230-14.0A2B-BOW-TF	14		22.0	2	8361615	
MC230-16.0A2B-BOW-TF	16		26.0	2	8361616	
MC230-18.0A2B-BOW-TF	18		26.0	2	8361617	
MC230-20.0A2B-BOW-TF	20		32.0	2	8361618	



Přihlaste se k odběru našeho newsletteru.

Navštivte naši FB skupinu.

walter-tools.com

Plánovaný termín zahájení je 1. dubna 2024. Trvání akce: 8 týdnů, resp. do vyprodání zásob. Dodací lhůta činí až pět pracovních dnů. Zboží v akci nelze vyměnit. Obrázky jsou ilustrativní. Změny vyhrazeny. Doporučená prodejní cena.

Rohová/drážkovací fréza ze slinutého karbidu MC230 Advance Xill-tec®

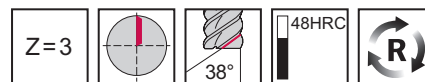
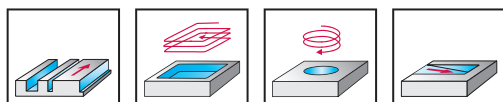

	P	M	K	N	S	H	O
WK40TF	●	●	●	●	●	●	●

Označení	D _c	R	L _c	z	SAP č.	Ks
MC230-02.0A3S-BOW-TF	2		3.0	3	8361676	
MC230-03.0A3S-BOW-TF	3		4.0	3	8361677	
MC230-04.0A3S-BOW-TF	4		5.0	3	8361678	
MC230-05.0A3S-BOW-TF	5		6.0	3	8361679	
MC230-06.0A3S-BOW-TF	6		7.0	3	8361680	
MC230-08.0A3S-BOW-TF	8		9.0	3	8361681	
MC230-10.0A3S-BOW-TF	10		11.0	3	8361675	
MC230-12.0A3S-BOW-TF	12		13.0	3	8361682	

Označení	D _c	R	L _c	z	SAP č.	Ks
MC230-01.0W3B-BOW-TF	1		3.0	3	8361729	
MC230-01.5W3B-BOW-TF	1.5		3.0	3	8361730	
MC230-02.0W3B-BOW-TF	2		6.0	3	8361728	
MC230-02.5W3B-BOW-TF	2.5		7.0	3	8361731	
MC230-03.0W3B-BOW-TF	3		7.0	3	8361732	
MC230-03.5W3B-BOW-TF	3.5		7.0	3	8361733	
MC230-04.0W3B-BOW-TF	4		8.0	3	8361734	
MC230-04.5W3B-BOW-TF	4.5		8.0	3	8361735	
MC230-05.0W3B-BOW-TF	5		10.0	3	8361736	
MC230-05.5W3B-BOW-TF	5.5		10.0	3	8361737	
MC230-06.0W3B-BOW-TF	6		10.0	3	8361738	
MC230-08.0W3B-BOW-TF	8		16.0	3	8361739	
MC230-09.0W3B-BOW-TF	9		16.0	3	8361740	
MC230-10.0W3B-BOW-TF	10		19.0	3	8361741	
MC230-12.0W3B-BOW-TF	12		22.0	3	8361742	
MC230-14.0W3B-BOW-TF	14		22.0	3	8361743	
MC230-16.0W3B-BOW-TF	16		26.0	3	8361744	
MC230-20.0W3B-BOW-TF	20		32.0	3	8361745	

Označení	D _c	R	L _c	z	SAP č.	Ks
MC230-02.0A3B-BOW-TF	2		6.0	3	8361619	
MC230-02.5A3B-BOW-TF	2.5		7.0	3	8361620	
MC230-03.0A3B-BOW-TF	3		7.0	3	8361621	
MC230-03.5A3B-BOW-TF	3.5		7.0	3	8361622	
MC230-04.0A3B-BOW-TF	4		8.0	3	8361623	
MC230-04.5A3B-BOW-TF	4.5		8.0	3	8361624	
MC230-05.0A3B-BOW-TF	5		10.0	3	8361625	
MC230-05.5A3B-BOW-TF	5.5		10.0	3	8361626	
MC230-06.0A3B-BOW-TF	6		10.0	3	8361627	
MC230-06.5A3B-BOW-TF	6.5		13.0	3	8361628	
MC230-07.0A3B-BOW-TF	7		13.0	3	8361629	
MC230-07.5A3B-BOW-TF	7.5		16.0	3	8361630	
MC230-08.0A3B-BOW-TF	8		16.0	3	8361631	
MC230-09.0A3B-BOW-TF	9		16.0	3	8361632	
MC230-10.0A3B-BOW-TF	10		19.0	3	8361633	
MC230-11.0A3B-BOW-TF	11		22.0	3	8361634	
MC230-12.0A3B-BOW-TF	12		22.0	3	8361635	
MC230-13.0A3B-BOW-TF	13		22.0	3	8361636	
MC230-14.0A3B-BOW-TF	14		22.0	3	8361637	
MC230-15.0A3B-BOW-TF	15		26.0	3	8361638	
MC230-16.0A3B-BOW-TF	16		26.0	3	8361639	
MC230-18.0A3B-BOW-TF	18		26.0	3	8361640	
MC230-20.0A3B-BOW-TF	20		32.0	3	8361641	



Přihlaste se k odběru našeho newsletteru.

Navštivte naši FB skupinu.

walter-tools.com

Plánovaný termín zahájení je 1. dubna 2024. Trvání akce: 8 týdnů, resp. do vyprodání zásob. Dodací lhůta činí až pět pracovních dnů. Zboží v akci nelze vyměnit. Obrázky jsou ilustrativní. Změny vyhrazeny. Doporučená prodejní cena.

Rohová/drážkovací fréza ze slinutého karbidu MC230 Advance

Xill-tec®

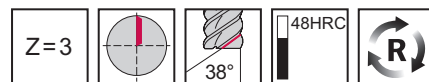
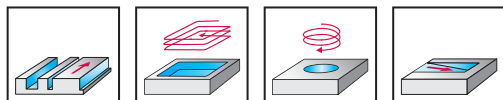

	P	M	K	N	S	H	O
WK40TF	●	●	●	●	●		

Označení	D _c	R	L _c	z	SAP č.	Ks
MC230-01.0A3BJ-BOW-TF	1		3.0	3	8361642	
MC230-01.1A3BJ-BOW-TF	1.1		3.0	3	8361643	
MC230-01.2A3BJ-BOW-TF	1.2		3.0	3	8361644	
MC230-01.3A3BJ-BOW-TF	1.3		3.0	3	8361645	
MC230-01.4A3BJ-BOW-TF	1.4		3.0	3	8361646	
MC230-01.5A3BJ-BOW-TF	1.5		3.0	3	8361647	
MC230-01.6A3BJ-BOW-TF	1.6		3.0	3	8361648	
MC230-01.7A3BJ-BOW-TF	1.7		3.0	3	8361649	
MC230-01.8A3BJ-BOW-TF	1.8		3.0	3	8361650	
MC230-01.9A3BJ-BOW-TF	1.9		3.0	3	8361651	
MC230-02.0A3BJ-BOW-TF	2		3.0	3	8361652	
MC230-02.1A3BJ-BOW-TF	2.1		3.0	3	8361653	
MC230-02.2A3BJ-BOW-TF	2.2		3.0	3	8361654	
MC230-02.3A3BJ-BOW-TF	2.3		3.0	3	8361655	
MC230-02.4A3BJ-BOW-TF	2.4		3.0	3	8361656	
MC230-02.5A3BJ-BOW-TF	2.5		3.0	3	8361657	
MC230-02.6A3BJ-BOW-TF	2.6		3.0	3	8361658	
MC230-02.7A3BJ-BOW-TF	2.7		3.0	3	8361659	
MC230-02.8A3BJ-BOW-TF	2.8		3.0	3	8361660	
MC230-02.9A3BJ-BOW-TF	2.9		3.0	3	8361661	
MC230-03.0A3BJ-BOW-TF	3		3.0	3	8361662	



Přihlaste se k odběru našeho newsletteru.

Navštivte naši FB skupinu.

walter-tools.com

Plánovaný termín zahájení je 1. dubna 2024. Trvání akce: 8 týdnů, resp. do vyprodání zásob. Dodací lhůta činí až pět pracovních dnů. Zboží v akci nelze vyměnit. Obrázky jsou ilustrativní. Změny vyhrazeny. Doporučená prodejní cena.

Rohová/drážkovací fréza ze slinutého karbidu MC230 Advance

Xill-tec®

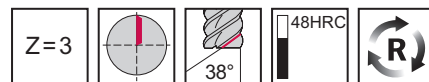
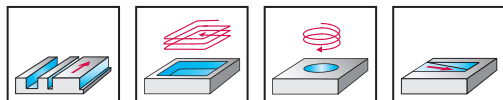

	P	M	K	N	S	H	O
WK40TF	●	●	●	●	●		

Označení	D _c	R	L _c	z	SAP č.	Ks
MC230-01.0A3L-BOW-TF	1		4.0	3	8361665	
MC230-01.5A3L-BOW-TF	1.5		6.0	3	8361666	
MC230-02.0A3L-BOW-TF	2		8.0	3	8361667	
MC230-03.0A3L-BOW-TF	3		12.0	3	8361663	
MC230-04.0A3L-BOW-TF	4		14.0	3	8361668	
MC230-05.0A3L-BOW-TF	5		16.0	3	8361669	
MC230-06.0A3L-BOW-TF	6		22.0	3	8361670	
MC230-08.0A3L-BOW-TF	8		28.0	3	8361671	
MC230-10.0A3L-BOW-TF	10		32.0	3	8361664	
MC230-12.0A3L-BOW-TF	12		38.0	3	8361672	
MC230-16.0A3L-BOW-TF	16		50.0	3	8361673	
MC230-20.0A3L-BOW-TF	20		50.0	3	8361674	



Přihlaste se k odběru našeho newsletteru.

Navštivte naši FB skupinu.

walter-tools.com

Plánovaný termín zahájení je 1. dubna 2024. Trvání akce: 8 týdnů, resp. do vyprodání zásob. Dodací lhůta činí až pět pracovních dnů. Zboží v akci nelze vyměnit. Obrázky jsou ilustrativní. Změny vyhrazeny. Doporučená prodejní cena.

Rohová/drážkovací fréza ze slinutého karbidu MC230 Advance Xill-tec®

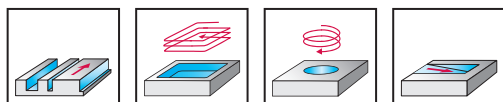

	P	M	K	N	S	H	O
WK40TF	●	●	●	●	●		

Označení	D _c	R	L _c	z	SAP č.	Ks
MC230-02.0A4S-BOW-TF	2		3.0	4	8361711	
MC230-03.0A4S-BOW-TF	3		4.0	4	8361712	
MC230-04.0A4S-BOW-TF	4		5.0	4	8361713	
MC230-05.0A4S-BOW-TF	5		6.0	4	8361714	
MC230-06.0A4S-BOW-TF	6		7.0	4	8361710	
MC230-08.0A4S-BOW-TF	8		9.0	4	8361715	
MC230-10.0A4S-BOW-TF	10		11.0	4	8361716	
MC230-12.0A4S-BOW-TF	12		13.0	4	8361717	



Přihlaste se k odběru našeho newsletteru.

Navštivte naši FB skupinu.

walter-tools.com

Plánovaný termín zahájení je 1. dubna 2024. Trvání akce: 8 týdnů, resp. do vyprodání zásob. Dodací lhůta činí až pět pracovních dnů. Zboží v akci nelze vyměnit. Obrázky jsou ilustrativní. Změny vyhrazeny. Doporučená prodejní cena.

Rohová/drážkovací fréza ze slinutého karbidu MC230 Advance Xill-tec®

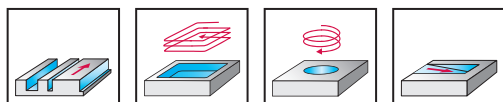

	P	M	K	N	S	H	O
WK40TF	●	●	●	●	●	●	●

Označení	D _c	R	L _c	z	SAP č.	Ks
MC230-02.0A4A-BOW-TF	2		4.0	4	8361684	
MC230-03.0A4A-BOW-TF	3		5.0	4	8361685	
MC230-04.0A4A-BOW-TF	4		8.0	4	8361686	
MC230-05.0A4A-BOW-TF	5		9.0	4	8361687	
MC230-06.0A4A-BOW-TF	6		10.0	4	8361688	
MC230-07.0A4A-BOW-TF	7		11.0	4	8361689	
MC230-08.0A4A-BOW-TF	8		12.0	4	8361690	
MC230-10.0A4A-BOW-TF	10		14.0	4	8361683	
MC230-12.0A4A-BOW-TF	12		16.0	4	8361691	
MC230-14.0A4A-BOW-TF	14		18.0	4	8361692	
MC230-16.0A4A-BOW-TF	16		22.0	4	8361693	
MC230-18.0A4A-BOW-TF	18		24.0	4	8361694	
MC230-20.0A4A-BOW-TF	20		26.0	4	8361695	

Označení	D _c	R	L _c	z	SAP č.	Ks
MC230-02.0W4A-BOW-TF	2		4.0	4	8361746	
MC230-03.0W4A-BOW-TF	3		5.0	4	8361747	
MC230-04.0W4A-BOW-TF	4		8.0	4	8361748	
MC230-05.0W4A-BOW-TF	5		9.0	4	8361749	
MC230-06.0W4A-BOW-TF	6		10.0	4	8361750	
MC230-08.0W4A-BOW-TF	8		12.0	4	8361751	
MC230-10.0W4A-BOW-TF	10		14.0	4	8361752	
MC230-12.0W4A-BOW-TF	12		16.0	4	8361753	
MC230-14.0W4A-BOW-TF	14		18.0	4	8361754	
MC230-16.0W4A-BOW-TF	16		22.0	4	8361755	
MC230-20.0W4A-BOW-TF	20		26.0	4	8361756	



Přihlaste se k odběru našeho newsletteru.

Navštivte naši FB skupinu.

walter-tools.com

Plánovaný termín zahájení je 1. dubna 2024. Trvání akce: 8 týdnů, resp. do vyprodání zásob. Dodací lhůta činí až pět pracovních dnů. Zboží v akci nelze vyměnit. Obrázky jsou ilustrativní. Změny vyhrazeny. Doporučená prodejní cena.

Rohová/drážkovací fréza ze slinutého karbidu MC230 Advance Xill-tec®

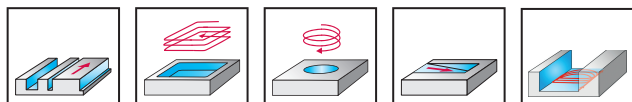

	P	M	K	N	S	H	O
WK40TF	●	●	●	●	●	●	●

Označení	D _c	R	L _c	z	SAP č.	Ks
MC230-02.0A4BC-BOW-TF	2		7.0	4	8194760	
MC230-02.5A4BC-BOW-TF	2.5		8.0	4	8194761	
MC230-03.0A4BC-BOW-TF	3		8.0	4	8194762	
MC230-03.5A4BC-BOW-TF	3.5		10.0	4	8194763	
MC230-04.0A4BC-BOW-TF	4		11.0	4	8194764	
MC230-04.5A4BC-BOW-TF	4.5		11.0	4	8194765	
MC230-05.0A4BC-BOW-TF	5		13.0	4	8194766	
MC230-05.5A4BC-BOW-TF	5.5		13.0	4	8194767	
MC230-06.0A4BC-BOW-TF	6		13.0	4	8194768	
MC230-06.5A4BC-BOW-TF	6.5		16.0	4	8194769	
MC230-07.0A4BC-BOW-TF	7		16.0	4	8194770	
MC230-08.0A4BC-BOW-TF	8		19.0	4	8194771	
MC230-09.0A4BC-BOW-TF	9		19.0	4	8194772	
MC230-10.0A4BC-BOW-TF	10		22.0	4	8194773	
MC230-12.0A4BC-BOW-TF	12		26.0	4	8194774	
MC230-14.0A4BC-BOW-TF	14		26.0	4	8194775	
MC230-16.0A4BC-BOW-TF	16		32.0	4	8194776	
MC230-18.0A4BC-BOW-TF	18		32.0	4	8194777	
MC230-20.0A4BC-BOW-TF	20		38.0	4	8194778	

Označení	D _c	R	L _c	z	SAP č.	Ks
MC230-02.0W4BC-BOW-TF	2		7.0	4	8194818	
MC230-02.5W4BC-BOW-TF	2.5		8.0	4	8194819	
MC230-03.0W4BC-BOW-TF	3		8.0	4	8194820	
MC230-04.0W4BC-BOW-TF	4		11.0	4	8194821	
MC230-05.0W4BC-BOW-TF	5		13.0	4	8194822	
MC230-06.0W4BC-BOW-TF	6		13.0	4	8194823	
MC230-07.0W4BC-BOW-TF	7		16.0	4	8194824	
MC230-08.0W4BC-BOW-TF	8		19.0	4	8194825	
MC230-09.0W4BC-BOW-TF	9		19.0	4	8194826	
MC230-10.0W4BC-BOW-TF	10		22.0	4	8194827	
MC230-12.0W4BC-BOW-TF	12		26.0	4	8194828	
MC230-14.0W4BC-BOW-TF	14		26.0	4	8194829	
MC230-16.0W4BC-BOW-TF	16		32.0	4	8194830	
MC230-18.0W4BC-BOW-TF	18		32.0	4	8194831	
MC230-20.0W4BC-BOW-TF	20		38.0	4	8194832	
MC230-25.0W4BC-BOW-TF	25		45.0	4	8194833	



Přihlaste se k odběru našeho newsletteru.

Navštivte naši FB skupinu.

walter-tools.com

Plánovaný termín zahájení je 1. dubna 2024. Trvání akce: 8 týdnů, resp. do vyprodání zásob. Dodací lhůta činí až pět pracovních dnů. Zboží v akci nelze vyměnit. Obrázky jsou ilustrativní. Změny vyhrazeny. Doporučená prodejní cena.

Rohová/drážkovací fréza ze slinutého karbidu MC230 Advance

Xill-tec®

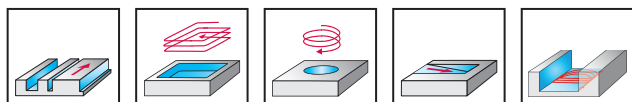

Označení	D _c	R	L _c	z	SAP č.	Ks
MC230-06.0A4LC-BOW-TF	6		13.0	4	8361793	
MC230-08.0A4LC-BOW-TF	8		19.0	4	8361794	
MC230-10.0A4LC-BOW-TF	10		22.0	4	8361795	
MC230-12.0A4LC-BOW-TF	12		26.0	4	8361796	
MC230-16.0A4LC-BOW-TF	16		32.0	4	8361797	
MC230-20.0A4LC-BOW-TF	20		38.0	4	8361798	

Označení	D _c	R	L _c	z	SAP č.	Ks
MC230-06.0W4LC-BOW-TF	6		13.0	4	8361799	
MC230-08.0W4LC-BOW-TF	8		19.0	4	8361800	
MC230-10.0W4LC-BOW-TF	10		22.0	4	8361801	
MC230-12.0W4LC-BOW-TF	12		26.0	4	8361802	
MC230-16.0W4LC-BOW-TF	16		32.0	4	8361803	
MC230-20.0W4LC-BOW-TF	20		38.0	4	8361804	



Přihlaste se k odběru našeho newsletteru.

Navštivte naši FB skupinu.

walter-tools.com

Plánovaný termín zahájení je 1. dubna 2024. Trvání akce: 8 týdnů, resp. do vyprodání zásob. Dodací lhůta činí až pět pracovních dnů. Zboží v akci nelze vyměnit. Obrázky jsou ilustrativní. Změny vyhrazeny. Doporučená prodejní cena.

Rohová/drážkovací fréza ze slinutého karbidu MC230 Advance

Xill-tec®

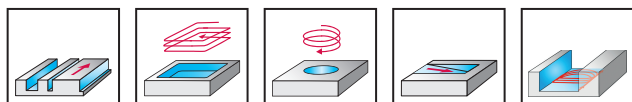

WK40TF	P	M	K	N	S	H	O
	●	●	●	●	●		

Označení	D _c	R	L _c	z	SAP č.	Ks
MC230-02.0A4B020C-BOW-TF	2	0.2	7.0	4	8194779	
MC230-03.0A4B030C-BOW-TF	3	0.3	8.0	4	8194780	
MC230-03.0A4B050C-BOW-TF	3	0.5	8.0	4	8194781	
MC230-04.0A4B020C-BOW-TF	4	0.2	11.0	4	8194782	
MC230-04.0A4B050C-BOW-TF	4	0.5	11.0	4	8194783	
MC230-05.0A4B050C-BOW-TF	5	0.5	13.0	4	8194784	
MC230-05.0A4B100C-BOW-TF	5	1	13.0	4	8194785	
MC230-06.0A4B050C-BOW-TF	6	0.5	13.0	4	8194786	
MC230-06.0A4B080C-BOW-TF	6	0.8	13.0	4	8194787	
MC230-06.0A4B100C-BOW-TF	6	1	13.0	4	8194788	
MC230-08.0A4B050C-BOW-TF	8	0.5	19.0	4	8194789	
MC230-08.0A4B080C-BOW-TF	8	0.8	19.0	4	8194790	
MC230-08.0A4B100C-BOW-TF	8	1	19.0	4	8194791	
MC230-08.0A4B150C-BOW-TF	8	1.5	19.0	4	8194792	
MC230-08.0A4B200C-BOW-TF	8	2	19.0	4	8194793	
MC230-10.0A4B050C-BOW-TF	10	0.5	22.0	4	8194794	
MC230-10.0A4B080C-BOW-TF	10	0.8	22.0	4	8194795	
MC230-10.0A4B100C-BOW-TF	10	1	22.0	4	8194796	
MC230-10.0A4B150C-BOW-TF	10	1.5	22.0	4	8194797	
MC230-10.0A4B200C-BOW-TF	10	2	22.0	4	8194798	
MC230-12.0A4B050C-BOW-TF	12	0.5	26.0	4	8194799	
MC230-12.0A4B080C-BOW-TF	12	0.8	26.0	4	8194800	
MC230-12.0A4B100C-BOW-TF	12	1	26.0	4	8194801	
MC230-12.0A4B150C-BOW-TF	12	1.5	26.0	4	8194802	
MC230-12.0A4B200C-BOW-TF	12	2	26.0	4	8194803	
MC230-12.0A4B250C-BOW-TF	12	2.5	26.0	4	8194804	
MC230-12.0A4B300C-BOW-TF	12	3	26.0	4	8194805	
MC230-16.0A4B050C-BOW-TF	16	0.5	32.0	4	8194806	

Označení	D _c	R	L _c	z	SAP č.	Ks
MC230-16.0A4B100C-BOW-TF	16	1	32.0	4	8194807	
MC230-16.0A4B200C-BOW-TF	16	2	32.0	4	8194808	
MC230-16.0A4B250C-BOW-TF	16	2.5	32.0	4	8194809	
MC230-16.0A4B300C-BOW-TF	16	3	32.0	4	8194810	
MC230-16.0A4B400C-BOW-TF	16	4	32.0	4	8194811	
MC230-20.0A4B050C-BOW-TF	20	0.5	38.0	4	8194812	
MC230-20.0A4B100C-BOW-TF	20	1	38.0	4	8194813	
MC230-20.0A4B200C-BOW-TF	20	2	38.0	4	8194814	
MC230-20.0A4B250C-BOW-TF	20	2.5	38.0	4	8194815	
MC230-20.0A4B300C-BOW-TF	20	3	38.0	4	8194816	
MC230-20.0A4B400C-BOW-TF	20	4	38.0	4	8194817	



Přihlaste se k odběru našeho newsletteru.

Navštivte naši FB skupinu.

walter-tools.com

Plánovaný termín zahájení je 1. dubna 2024. Trvání akce: 8 týdnů, resp. do vyprodání zásob. Dodací lhůta činí až pět pracovních dnů. Zboží v akci nelze vyměnit. Obrázky jsou ilustrativní. Změny vyhrazeny. Doporučená prodejní cena.

Rohová/drážkovací fréza ze slinutého karbidu MC230 Advance

Xill-tec®

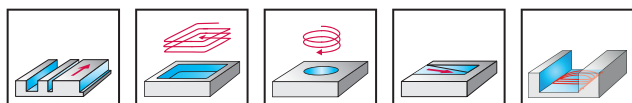

Wk40TF	P	M	K	N	S	H	O
	●	●	●	●	●		

Označení	D _c	R	L _c	z	SAP č.	Ks
MC230-05.0W4B050C-BOW-TF	5	0.5	13.0	4	8194834	
MC230-06.0W4B050C-BOW-TF	6	0.5	13.0	4	8194835	
MC230-06.0W4B080C-BOW-TF	6	0.8	13.0	4	8194836	
MC230-06.0W4B100C-BOW-TF	6	1	13.0	4	8194837	
MC230-08.0W4B050C-BOW-TF	8	0.5	19.0	4	8194838	
MC230-08.0W4B080C-BOW-TF	8	0.8	19.0	4	8194839	
MC230-08.0W4B100C-BOW-TF	8	1	19.0	4	8194840	
MC230-08.0W4B150C-BOW-TF	8	1.5	19.0	4	8194841	
MC230-08.0W4B200C-BOW-TF	8	2	19.0	4	8194842	
MC230-10.0W4B050C-BOW-TF	10	0.5	22.0	4	8194843	
MC230-10.0W4B080C-BOW-TF	10	0.8	22.0	4	8194844	
MC230-10.0W4B100C-BOW-TF	10	1	22.0	4	8194845	
MC230-10.0W4B150C-BOW-TF	10	1.5	22.0	4	8194846	
MC230-10.0W4B200C-BOW-TF	10	2	22.0	4	8194847	
MC230-12.0W4B050C-BOW-TF	12	0.5	26.0	4	8194848	
MC230-12.0W4B080C-BOW-TF	12	0.8	26.0	4	8194849	
MC230-12.0W4B100C-BOW-TF	12	1	26.0	4	8194850	
MC230-12.0W4B150C-BOW-TF	12	1.5	26.0	4	8194851	
MC230-12.0W4B200C-BOW-TF	12	2	26.0	4	8194852	
MC230-12.0W4B250C-BOW-TF	12	2.5	26.0	4	8194853	
MC230-12.0W4B300C-BOW-TF	12	3	26.0	4	8194854	
MC230-16.0W4B050C-BOW-TF	16	0.5	32.0	4	8194855	
MC230-16.0W4B100C-BOW-TF	16	1	32.0	4	8194856	
MC230-16.0W4B200C-BOW-TF	16	2	32.0	4	8194857	
MC230-16.0W4B250C-BOW-TF	16	2.5	32.0	4	8194858	
MC230-16.0W4B300C-BOW-TF	16	3	32.0	4	8194859	
MC230-16.0W4B400C-BOW-TF	16	4	32.0	4	8194860	
MC230-20.0W4B050C-BOW-TF	20	0.5	38.0	4	8194861	

Označení	D _c	R	L _c	z	SAP č.	Ks
MC230-20.0W4B100C-BOW-TF	20	1	38.0	4	8194862	
MC230-20.0W4B200C-BOW-TF	20	2	38.0	4	8194863	
MC230-20.0W4B250C-BOW-TF	20	2.5	38.0	4	8194864	
MC230-20.0W4B300C-BOW-TF	20	3	38.0	4	8194865	
MC230-20.0W4B400C-BOW-TF	20	4	38.0	4	8194866	
MC230-25.0W4B100C-BOW-TF	25	1	45.0	4	8194867	
MC230-25.0W4B200C-BOW-TF	25	2	45.0	4	8194868	
MC230-25.0W4B300C-BOW-TF	25	3	45.0	4	8194869	
MC230-25.0W4B400C-BOW-TF	25	4	45.0	4	8194870	



Přihlaste se k odběru našeho newsletteru.

Navštivte naši FB skupinu.

walter-tools.com

Plánovaný termín zahájení je 1. dubna 2024. Trvání akce: 8 týdnů, resp. do vyprodání zásob. Dodací lhůta činí až pět pracovních dnů. Zboží v akci nelze vyměnit. Obrázky jsou ilustrativní. Změny vyhrazeny. Doporučená prodejní cena.

Rohová/drážkovací fréza ze slinutého karbidu MC230 Advance

Xill-tec®

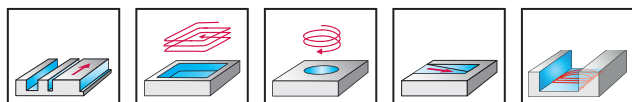

	P	M	K	N	S	H	O
WK40TF	●	●	●	●	●	●	●

Označení	D _c	R	L _c	z	SAP č.	Ks
MC230-06.0A4L050C-BOW-TF	6	0.5	13.0	4	8361805	
MC230-06.0A4L100C-BOW-TF	6	1	13.0	4	8361806	
MC230-08.0A4L050C-BOW-TF	8	0.5	19.0	4	8361807	
MC230-08.0A4L100C-BOW-TF	8	1	19.0	4	8361808	
MC230-08.0A4L200C-BOW-TF	8	2	19.0	4	8361809	
MC230-10.0A4L050C-BOW-TF	10	0.5	22.0	4	8361810	
MC230-10.0A4L100C-BOW-TF	10	1	22.0	4	8361811	
MC230-10.0A4L200C-BOW-TF	10	2	22.0	4	8361812	
MC230-12.0A4L050C-BOW-TF	12	0.5	26.0	4	8361813	
MC230-12.0A4L100C-BOW-TF	12	1	26.0	4	8361814	
MC230-12.0A4L200C-BOW-TF	12	2	26.0	4	8361815	
MC230-12.0A4L300C-BOW-TF	12	3	26.0	4	8361816	
MC230-16.0A4L100C-BOW-TF	16	1	32.0	4	8361817	
MC230-16.0A4L200C-BOW-TF	16	2	32.0	4	8361818	
MC230-16.0A4L400C-BOW-TF	16	4	32.0	4	8361819	
MC230-20.0A4L100C-BOW-TF	20	1	38.0	4	8361820	
MC230-20.0A4L200C-BOW-TF	20	2	38.0	4	8361821	
MC230-20.0A4L400C-BOW-TF	20	4	38.0	4	8361822	



Přihlaste se k odběru našeho newsletteru.

Navštivte naši FB skupinu.

walter-tools.com

Plánovaný termín zahájení je 1. dubna 2024. Trvání akce: 8 týdnů, resp. do vyprodání zásob. Dodací lhůta činí až pět pracovních dnů. Zboží v akci nelze vyměnit. Obrázky jsou ilustrativní. Změny vyhrazeny. Doporučená prodejní cena.

Rohová/drážkovací fréza ze slinutého karbidu MC230 Advance

Xill-tec®

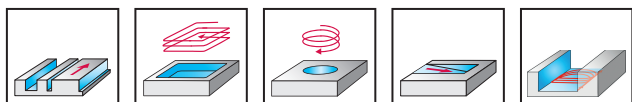

	P	M	K	N	S	H	O
WK40TF	●●	●	●	●	●		

Označení	D _c	R	L _c	z	SAP č.	Ks
MC230-06.0W5B-BOW-TF	6		13.0	5	8361757	
MC230-08.0W5B-BOW-TF	8		19.0	5	8361758	
MC230-10.0W5B-BOW-TF	10		22.0	5	8361759	
MC230-12.0W5B-BOW-TF	12		26.0	5	8361760	
MC230-16.0W5B-BOW-TF	16		32.0	5	8361761	
MC230-20.0W5B-BOW-TF	20		38.0	5	8361762	



Přihlaste se k odběru našeho newsletteru.

Navštivte naši FB skupinu.

walter-tools.com

Plánovaný termín zahájení je 1. dubna 2024. Trvání akce: 8 týdnů, resp. do vyprodání zásob. Dodací lhůta činí až pět pracovních dnů. Zboží v akci nelze vyměnit. Obrázky jsou ilustrativní. Změny vyhrazeny. Doporučená prodejní cena.

Rohová/drážkovací fréza ze slinutého karbidu MC230 Advance

Xill-tec®

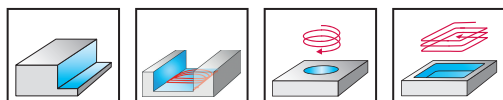

	P	M	K	N	S	H	O
WK40TF	●	●	●	●	●		

Označení	D _c	R	L _c	z	SAP č.	Ks
MC230-06.0W5L-BOW-TF	6		22.0	5	8361763	
MC230-08.0W5L-BOW-TF	8		28.0	5	8361765	
MC230-10.0W5L-BOW-TF	10		32.0	5	8361766	
MC230-12.0W5L-BOW-TF	12		40.0	5	8361764	



Přihlaste se k odběru našeho newsletteru.

Navštivte naši FB skupinu.

walter-tools.com

Plánovaný termín zahájení je 1. dubna 2024. Trvání akce: 8 týdnů, resp. do vyprodání zásob. Dodací lhůta činí až pět pracovních dnů. Zboží v akci nelze vyměnit. Obrázky jsou ilustrativní. Změny vyhrazeny. Doporučená prodejní cena.

Rohová/drážkovací fréza ze slinutého karbidu MC230 Advance

Xill-tec®

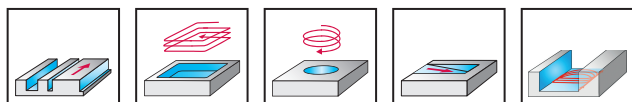

	P	M	K	N	S	H	O
WK40TF	●	●	●	●	●	●	●

Označení	D _c	R	L _c	z	SAP č.	Ks
MC230-06.0A4L-BOW-TF	6		22.0	4	8361698	
MC230-08.0A4L-BOW-TF	8		28.0	4	8361699	
MC230-10.0A4L-BOW-TF	10		32.0	4	8361696	
MC230-12.0A4L-BOW-TF	12		40.0	4	8361700	
MC230-14.0A4L-BOW-TF	14		50.0	4	8361701	
MC230-16.0A5L-BOW-TF	16		50.0	5	8361702	
MC230-20.0A5L-BOW-TF	20		55.0	5	8361703	
MC230-20.0A6LJ-BOW-TF	20		75.0	6	8361718	
MC230-25.0A8LJ-BOW-TF	25		90.0	8	8361719	

Označení	D _c	R	L _c	z	SAP č.	Ks
MC230-06.0W4L-BOW-TF	6		22.0	4	8361704	
MC230-08.0W4L-BOW-TF	8		28.0	4	8361705	
MC230-10.0W4L-BOW-TF	10		32.0	4	8361706	
MC230-12.0W4L-BOW-TF	12		40.0	4	8361707	
MC230-14.0W4L-BOW-TF	14		50.0	4	8361708	
MC230-16.0W5L-BOW-TF	16		50.0	5	8361697	
MC230-20.0W5L-BOW-TF	20		55.0	5	8361709	
MC230-20.0W6LJ-BOW-TF	20		75.0	6	8361767	
MC230-25.0W8LJ-BOW-TF	25		90.0	8	8361768	



Přihlaste se k odběru našeho newsletteru.

Navštivte naši FB skupinu.

walter-tools.com

Plánovaný termín zahájení je 1. dubna 2024. Trvání akce: 8 týdnů, resp. do vyprodání zásob. Dodací lhůta činí až pět pracovních dnů. Zboží v akci nelze vyměnit. Obrázky jsou ilustrativní. Změny vyhrazeny. Doporučená prodejní cena.

Rohová/drážkovací fréza ze slinutého karbidu MC230 Advance Xill-tec®

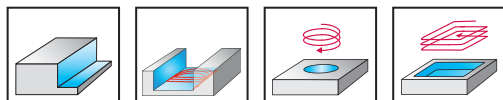

	P	M	K	N	S	H	O
WK40TF	●	●	●	●	●	●	●

Označení	D _c	R	L _c	z	SAP č.	Ks
MC230-06.0A4XL-BOW-TF	6		30.0	4	8361722	
MC230-08.0A4XL-BOW-TF	8		40.0	4	8361723	
MC230-10.0A4XL-BOW-TF	10		50.0	4	8361724	
MC230-12.0A4XL-BOW-TF	12		60.0	4	8361725	
MC230-16.0A5XK-BOW-TF	16		65.0	5	8361720	
MC230-16.0A5XL-BOW-TF	16		80.0	5	8361721	
MC230-20.0A6XL-BOW-TF	20		100.0	6	8361726	
MC230-25.0A8XL-BOW-TF	25		125.0	8	8361727	

Označení	D _c	R	L _c	z	SAP č.	Ks
MC230-04.0W4XL-BOW-TF	4		20.0	4	8361772	
MC230-05.0W4XL-BOW-TF	5		25.0	4	8361773	
MC230-06.0W4XL-BOW-TF	6		30.0	4	8361774	
MC230-08.0W4XL-BOW-TF	8		40.0	4	8361775	
MC230-10.0W4XL-BOW-TF	10		50.0	4	8361770	
MC230-12.0W4XL-BOW-TF	12		60.0	4	8361776	
MC230-14.0W4XL-BOW-TF	14		70.0	4	8361777	
MC230-16.0W5XK-BOW-TF	16		65.0	5	8361769	
MC230-16.0W5XL-BOW-TF	16		80.0	5	8361778	
MC230-18.0W5XL-BOW-TF	18		90.0	5	8361779	
MC230-20.0W6XL-BOW-TF	20		100.0	6	8361771	
MC230-25.0W8XL-BOW-TF	25		125.0	8	8361780	



Přihlaste se k odběru našeho newsletteru.

Navštivte naši FB skupinu.

walter-tools.com

Plánovaný termín zahájení je 1. dubna 2024. Trvání akce: 8 týdnů, resp. do vyprodání zásob. Dodací lhůta činí až pět pracovních dnů. Zboží v akci nelze vyměnit. Obrázky jsou ilustrativní. Změny vyhrazeny. Doporučená prodejní cena.

Rohová/drážkovací fréza ze slinutého karbidu MC233 Advance

Xill-tec®

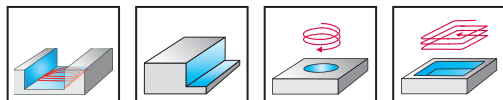

	P	M	K	N	S	H	O
WK40TF	●●	●	●	●	●		

Označení	D _c	R	L _c	z	SAP č.	Ks
MC233-08.0W4L-BOW-TF	8		28.0	4	8361781	
MC233-10.0W4L-BOW-TF	10		32.0	4	8361782	
MC233-12.0W4L-BOW-TF	12		40.0	4	8361783	
MC233-16.0W5L-BOW-TF	16		50.0	5	8361784	
MC233-20.0W5L-BOW-TF	20		55.0	5	8361785	
MC233-25.0W8LJ-BOW-TF	25		90.0	8	8361786	

Označení	D _c	R	L _c	z	SAP č.	Ks
MC233-08.0W4XL-BOW-TF	8		40.0	4	8361787	
MC233-10.0W4XL-BOW-TF	10		50.0	4	8361789	
MC233-12.0W4XL-BOW-TF	12		60.0	4	8361790	
MC233-16.0W5XL-BOW-TF	16		80.0	5	8361791	
MC233-20.0W6XL-BOW-TF	20		100.0	6	8361792	
MC233-25.0W8XL-BOW-TF	25		125.0	8	8361788	



Přihlaste se k odběru našeho newsletteru.

Navštivte naši FB skupinu.

walter-tools.com

Plánovaný termín zahájení je 1. dubna 2024. Trvání akce: 8 týdnů, resp. do vyprodání zásob. Dodací lhůta činí až pět pracovních dnů. Zboží v akci nelze vyměnit. Obrázky jsou ilustrativní. Změny vyhrazeny. Doporučená prodejní cena.

Walter CZ s.r.o.

Blanenská 1769, 664 34 Kuřim
Česká republika

+420 541 423 352
service.cz@walter-tools.com
walter-tools.com

